

LAZZARI

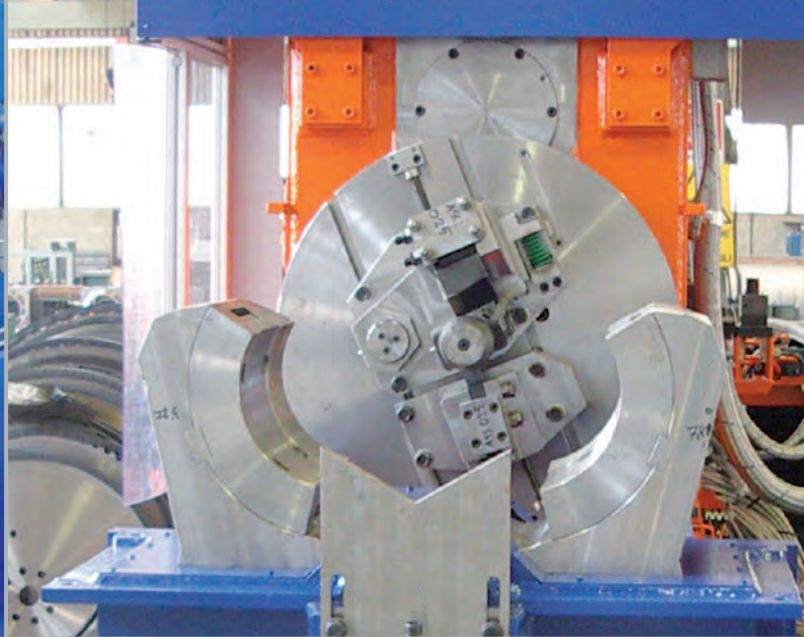

Officine meccaniche Impianti industriali S.p.A.

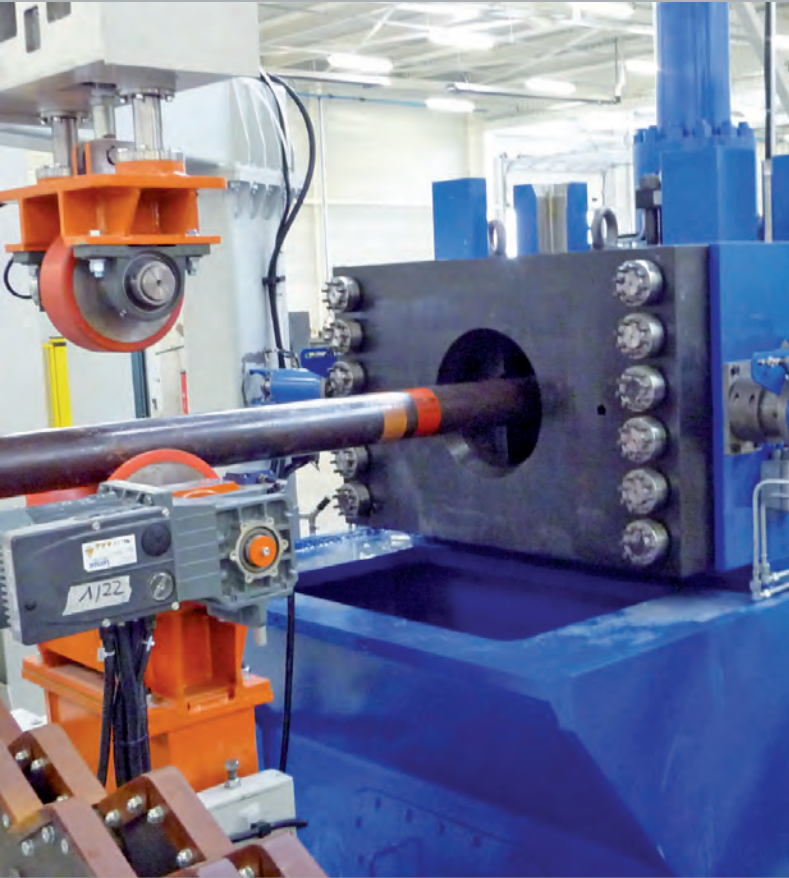

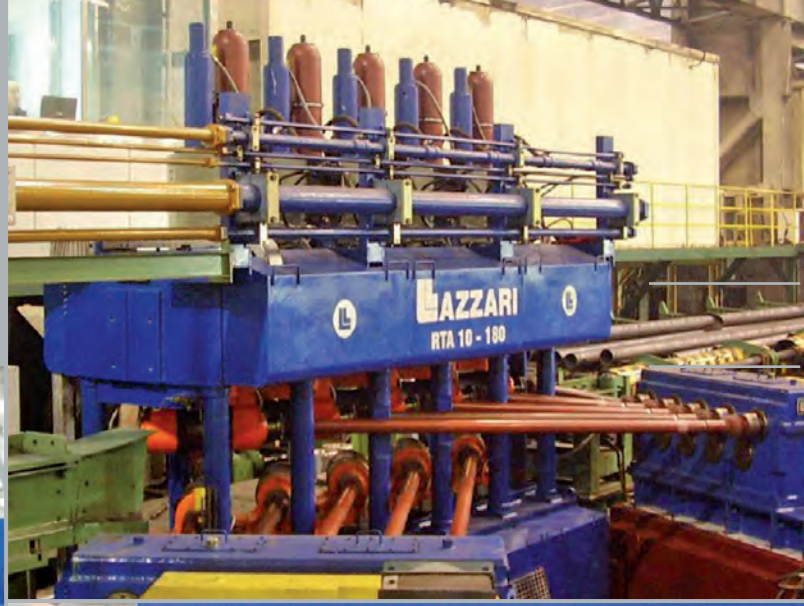
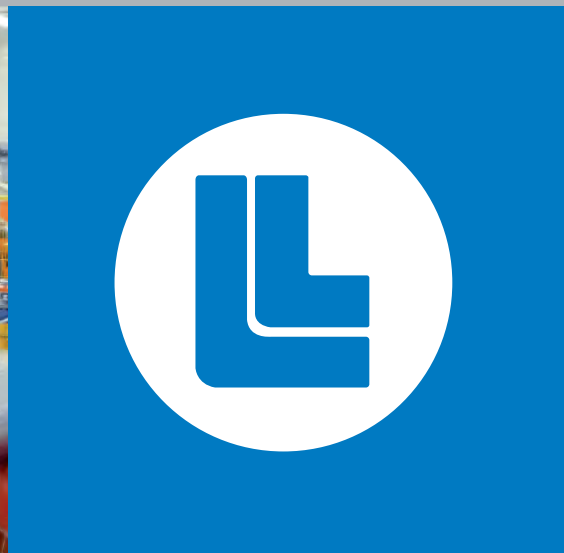
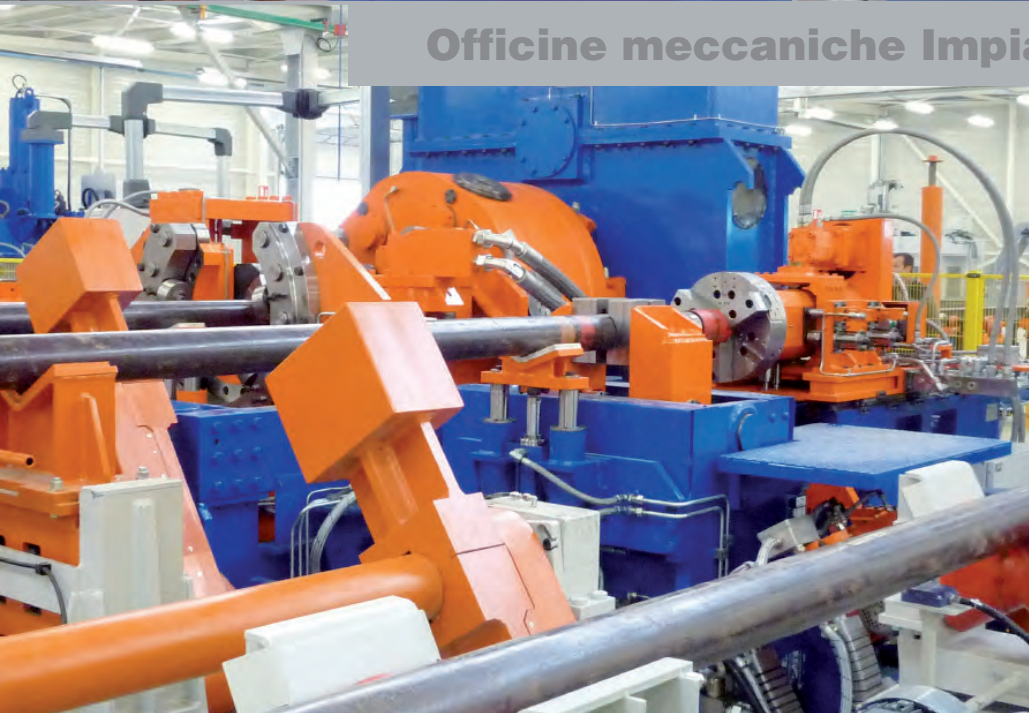
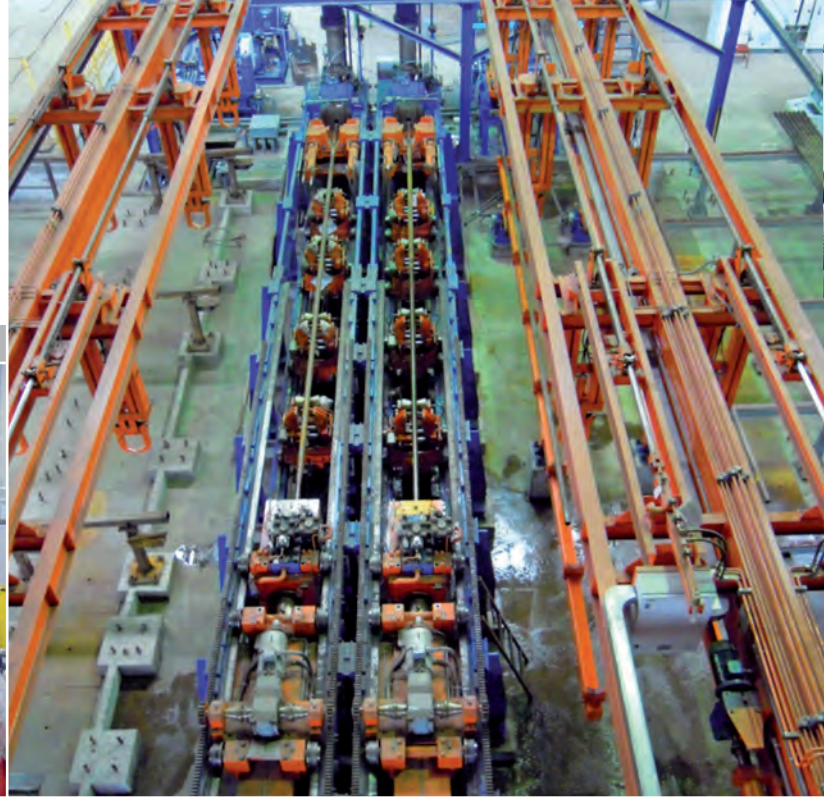

LAZZARI FACER AND BEVELER

Pipe diameters mm	Pipe diameters inch	Type
26,7 ÷ 196,85	1,050" ÷ 7 ¾"	FB200
114,3 ÷ 298,45	4 ½" ÷ 11 ¾"	FB300
196,85 ÷ 406,4	7 ¾" ÷ 16"	FB400
298,45 ÷ 508,0	11 ¾" ÷ 20"	FB500

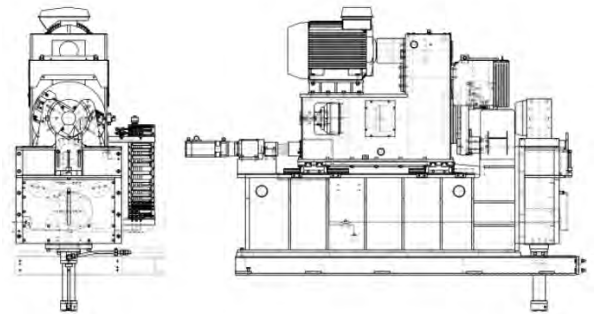

LAZZARI COUPLING MAKEUP

Pipe diameters mm	Pipe diameters inch	Model
26,7 ÷ 196,85	1,050" ÷ 7 ¾"	CM200(*)-SD
114,3 ÷ 298,45	4 ½" ÷ 11 ¾"	CM300(*)-SD
196,85 ÷ 406,4	7 ¾" ÷ 16"	CM400(*)-SD
298,45 ÷ 508,0	11 ¾" ÷ 20"	CM500(*)-SD

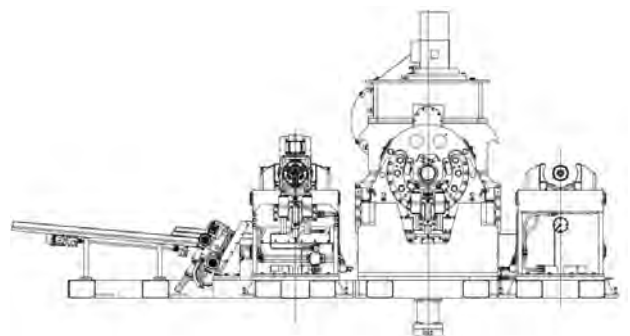

(*)

Low Torque	Hight Torque
LT	HT

Upon request With Long Drifter -LD instead of -SD

LAZZARI DRIFTER

Pipe diameters mm	Pipe diameters inch	Model
60,3 ÷ 177,8	2 ⅜" ÷ 7"	LD200
168,3 ÷ 298,5	6 ⅝" ÷ 11 ¾"	LD300
168,3 ÷ 406,4	6 ⅝" ÷ 16"	LD400
168,3 ÷ 508	6 ⅝" ÷ 20"	LD500

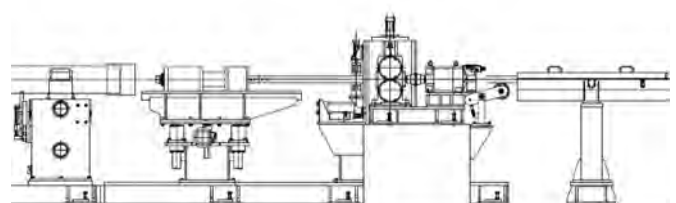

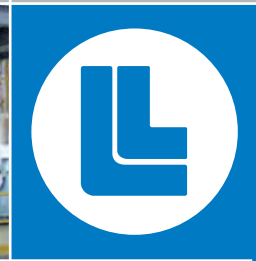
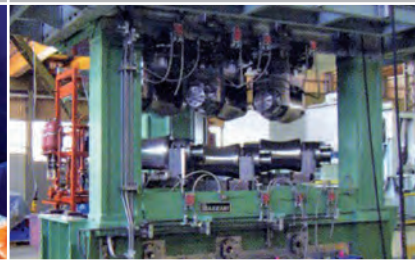
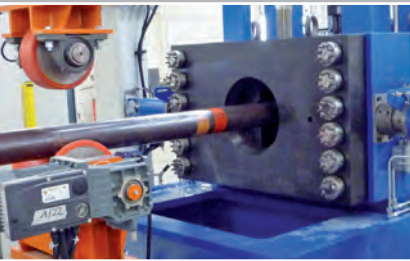

LAZZARI HYDROTESTER

(full pipe length with or without coupling)

Pipe diameters mm	Pipe diameters inch	Model
26,7 ÷ 196,85	1,050" ÷ 7 ¾"	HT200/(*)
114,3 ÷ 298,45	4 ½" ÷ 11 ¾"	HT300/(*)
196,85 ÷ 406,4	7 ¾" ÷ 16"	HT400/(*)
298,45 ÷ 508,0	11 ¾" ÷ 20"	HT500/(*)

(*)

Testing Pressure MPa (Bar)
80 (800)
135 (1350)

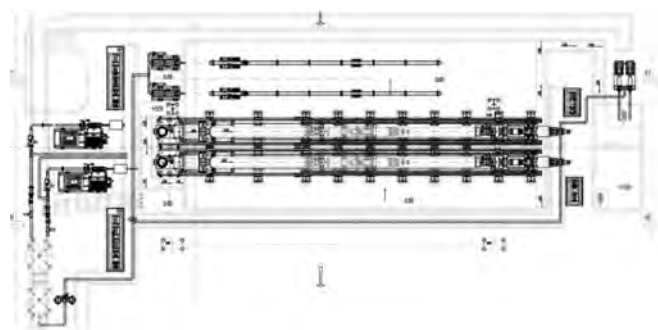

LAZZARI LEAK TESTER

(pipe ends with coupling)

Pipe diameters mm	Pipe diameters inch	Model
26,7 ÷ 196,85	1,050" ÷ 7 ¾"	HTE200/(*)
114,3 ÷ 298,45	4 ½" ÷ 11 ¾"	HTE300/(*)
196,85 ÷ 406,4	7 ¾" ÷ 16"	HTE400/(*)
298,45 ÷ 508,0	11 ¾" ÷ 20"	HTE500/(*)

(*)

Testing Pressure MPa (Bar)
80 (800)
135 (1350)

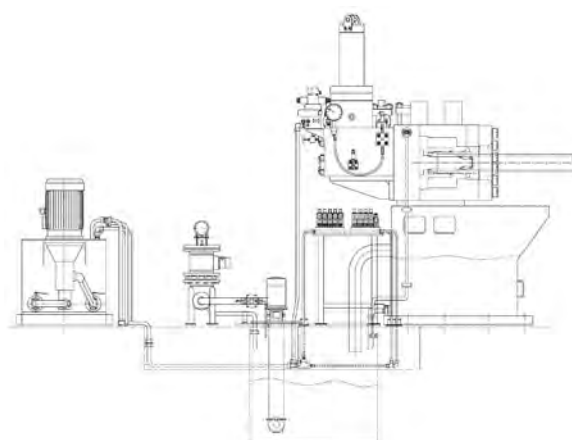

LAZZARI STRAIGHTENER

Pipe diameters mm	Pipe diameters inch	Model
26,7 ÷ 196,85	1,050" ÷ 7 ¾"	RT200(*)-(**)
114,3 ÷ 298,45	4 ½" ÷ 11 ¾"	RT300(*)-(**)
196,85 ÷ 406,4	7 ¾" ÷ 16"	RT400(*)-(**)
298,45 ÷ 508,0	11 ¾" ÷ 20"	RT500(*)-(**)

(*)

Pipe temperature	
<400°C	>400°C
C	H

(**)

Roll number	
6	10

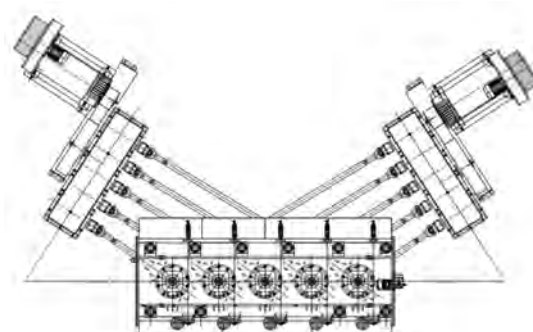



LAZZARI

LAZZARI - OFFICINE MECCANICHE
IMPIANTI INDUSTRIALI - S.p.A.

Via A. Volta, 3
24036 PONTE S.PIETRO (BG) - ITALY
Tel. +39 035 611316 Fax +39 035 612402
e-mail:lazzari@lazzarigroup.com

www.lazzarigroup.com

